

Features

- Low On-Resistance
- Very Low Gate Threshold Voltage, 0.9V Max.
- Fast Switching Speed
- Low Input/Output Leakage
- Ultra-Small Surface Mount Package
- **Totally Lead-Free & Fully RoHS Compliant (Notes 1 & 2)**
- **Halogen and Antimony Free. "Green" Device (Note 3)**
- **ESD Protected Gate**
- **Ultra Low Profile Package**
- **Qualified to AEC-Q101 Standards for High Reliability**

Mechanical Data

- Case: X2-DFN1006-3
- Case Material: Molded Plastic, "Green" Molding Compound; UL Flammability Classification Rating 94V-0
- Moisture Sensitivity: Level 1 per J-STD-020
- Terminal Connections: See Diagram
- Terminals: Finish — NiPdAu over Copper leadframe; Solderable per MIL-STD-202, Method 208 [\(4\)](#)
- Weight: 0.001 grams (Approximate)

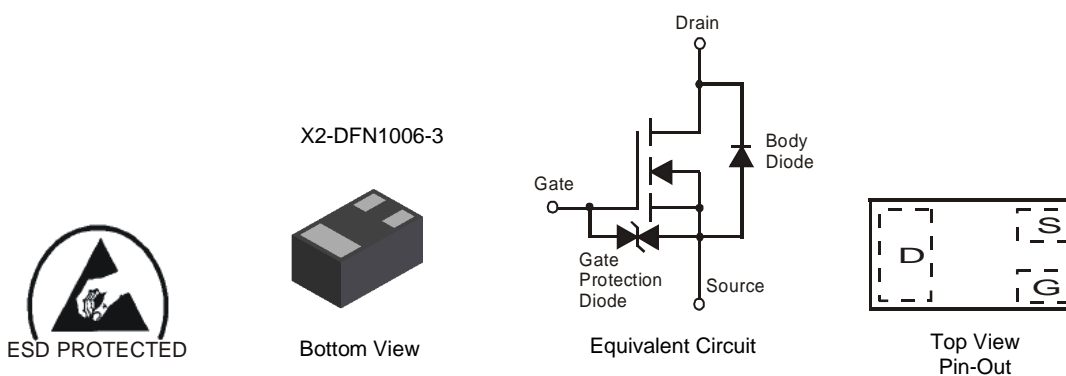



Ordering Information (Note 4)

Part Number	Marking	Reel size (inches)	Tape width (mm)	Quantity per reel
DMN2005LP4K-7	DN	7	8	3,000
DMN2005LP4K-7B	DN	7	8	10,000

Notes:

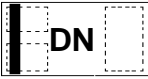
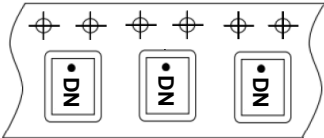
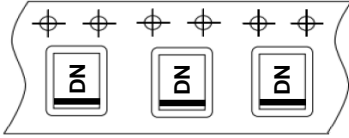
Marking Information

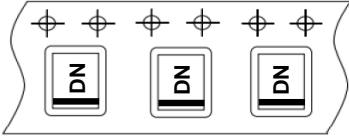
<p>DMN2005LPK-7</p>	<p> Top View Dot Denotes Drain Side</p> <p>From date code 1527 (YYWW), this changes to:</p> <p> Top View Bar Denotes Gate and Source Side</p> <p></p> <p></p>
<p>DMN2005LPK-7B</p>	<p> Top View Bar Denotes Gate and Source Side</p> <p>DN = Part Marking Code</p> <p></p>

Maximum Ratings (@T_A = +25°C unless otherwise specified.)

Characteristic	Symbol	Value	Unit
Drain-Source Voltage	V _{DSS}	20	V
Gate-Source Voltage	V _{GSS}	±10	V
Drain Current per element (Note 5)	I _D	Continuous	300
		Pulsed (Note 6)	350

Thermal Characteristics (@T_A = +25°C unless otherwise specified.)

Characteristic	Symbol	Value	Unit
Total Power Dissipation (Note 5)	P _D	400	mW
Thermal Resistance, Junction to Ambient	R _{θJA}	280	°C/W
Operating and Storage Temperature Range	T _J , T _{STG}	-65 to +150	°C

Electrical Characteristics (@T_A = +25°C unless otherwise specified.)

Characteristic	Symbol	Min	Typ	Max	Unit	Test Condition
OFF CHARACTERISTICS (per element) (Note 7)						
Drain-Source Breakdown Voltage	BV _{DSS}	20	—	—	V	V _{GS} = 0V, I _D = 100μA
Zero Gate Voltage Drain Current	I _{DSS}	—	—	10	μA	V _{DS} = 17V, V _{GS} = 0V
Gate-Source Leakage	I _{GSS}	—	—	±5	μA	V _{GS} = ±8V, V _{DS} = 0V
ON CHARACTERISTICS (per element) (Note 7)						
Gate Threshold Voltage	V _{GS(th)}	0.53	—	0.9	V	V _{DS} = V _{GS} , I _D = 100μA
Static Drain-Source On-Resistance	R _{DS(on)}	—	0.35	1.5	Ω	V _{GS} = 4V, I _D = 10mA
		—	0.4	1.7		V _{GS} = 2.7V, I _D = 200mA
		—	0.45	1.7		V _{GS} = 2.5V, I _D = 10mA
		—	0.55	3.5		V _{GS} = 1.8V, I _D = 200mA
		—	0.65	3.5		V _{GS} = 1.5V, I _D = 1mA
Forward Transfer Admittance	Y _{fs}	40	—	—	mS	V _{DS} = 3V, I _D = 10mA
DYNAMIC CHARACTERISTICS						
Input Capacitance	C _{iss}	—	37.1	—	pF	V _{DS} = 10V, V _{GS} = 0V f = 1.0MHz
Output Capacitance	C _{oss}	—	6.5	—	pF	
Reverse Transfer Capacitance	C _{rss}	—	4.8	—	pF	
Switching Time	Turn-On Time	t _{on}	—	4.06	nS	V _{DD} = 10V, R _I = 47Ω, V _{GEN} = 4.5V, R _{GEN} = 10Ω.
	Turn-Off Time	t _{off}	—	13.7		

- Notes:
- Device mounted on FR-4 PCB.
 - Pulse width ≤10μs, Duty Cycle ≤1%.
 - Short duration pulse test used to minimize self-heating effect.

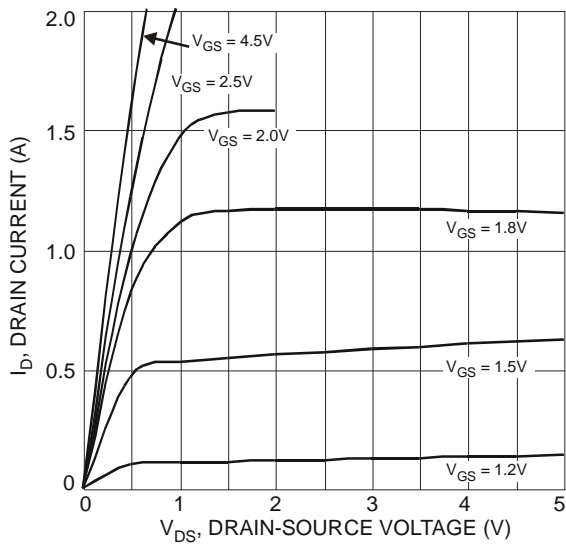

Fig. 1 Typical Output Characteristics

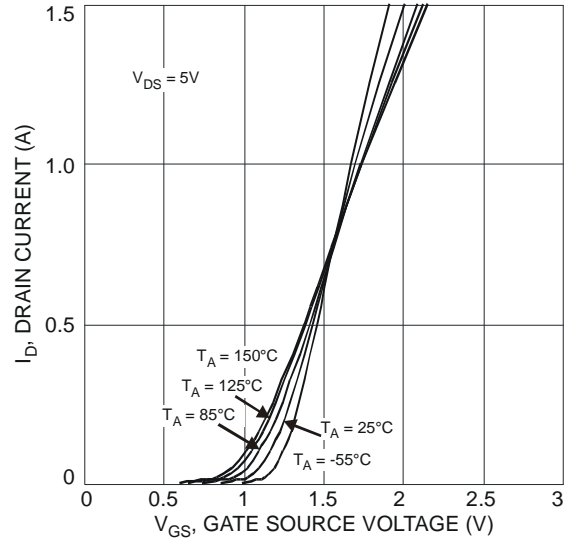

Fig. 2 Typical Transfer Characteristics

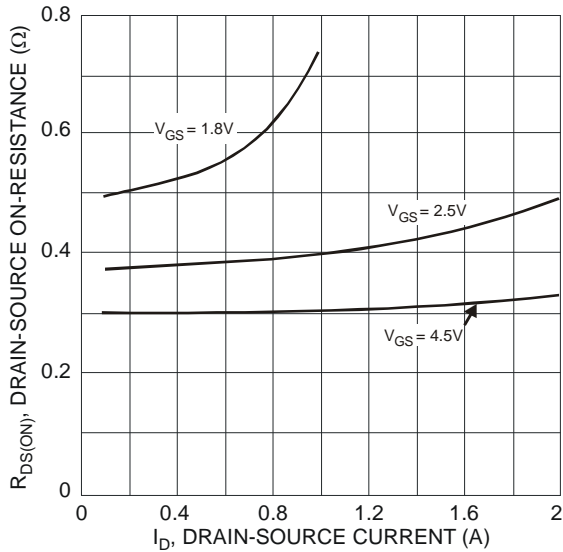

Fig. 3 Typical On-Resistance vs. Drain Current and Gate Voltage

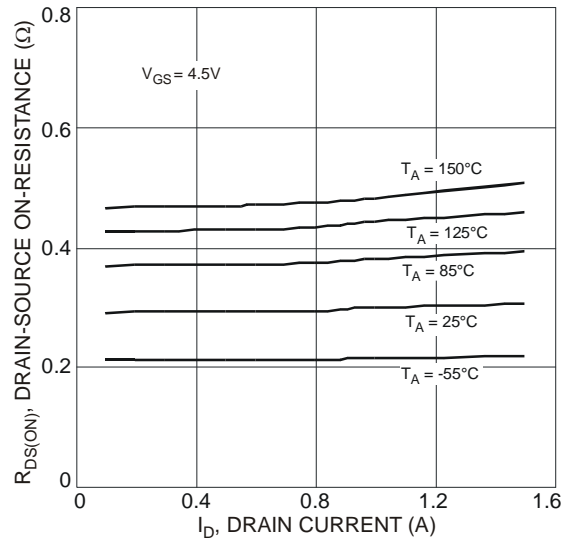

Fig. 4 Typical Drain-Source On-Resistance vs. Drain Current and Temperature

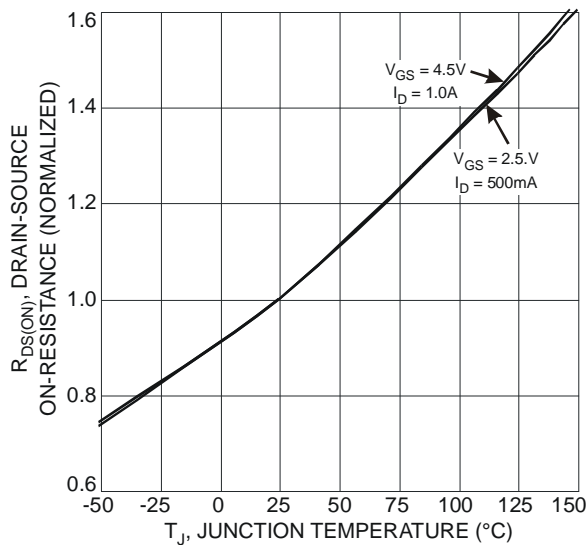

Fig. 5 On-Resistance Variation with Temperature

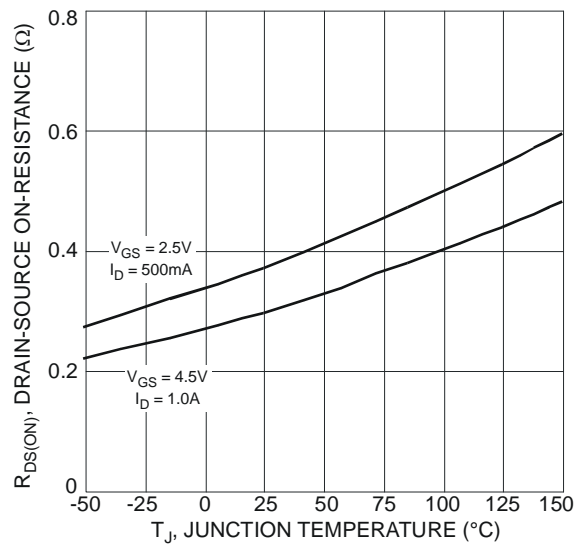

Fig. 6 On-Resistance Variation with Temperature

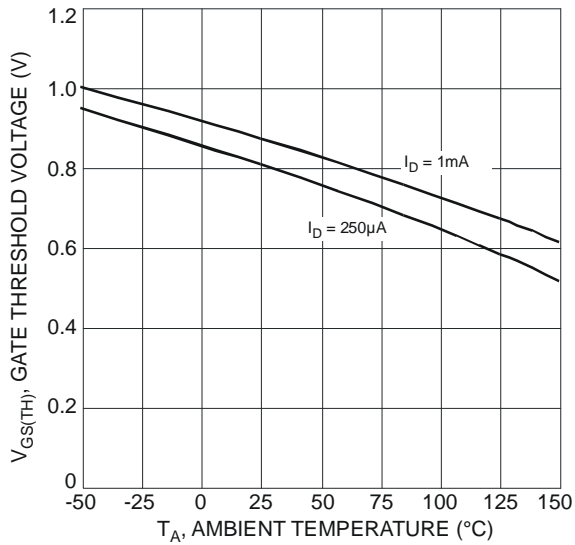

Fig. 7 Gate Threshold Variation vs. Ambient Temperature

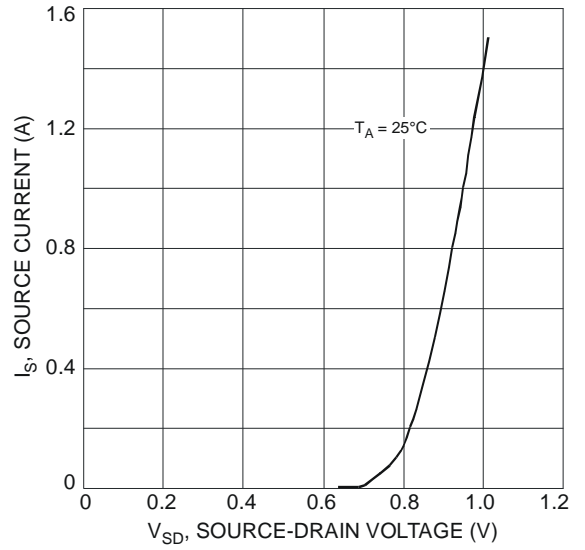

Fig. 8 Diode Forward Voltage vs. Current

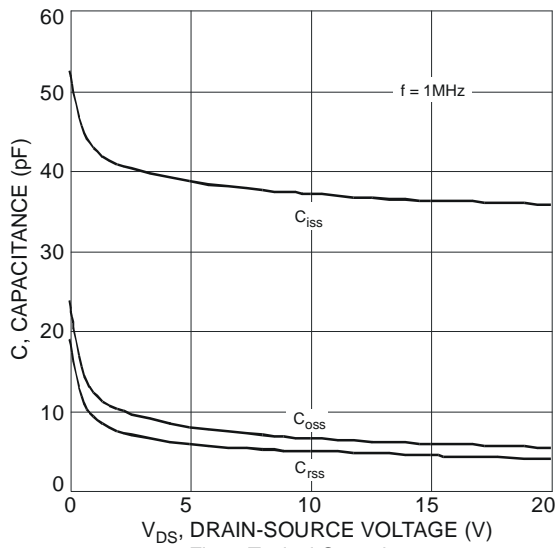
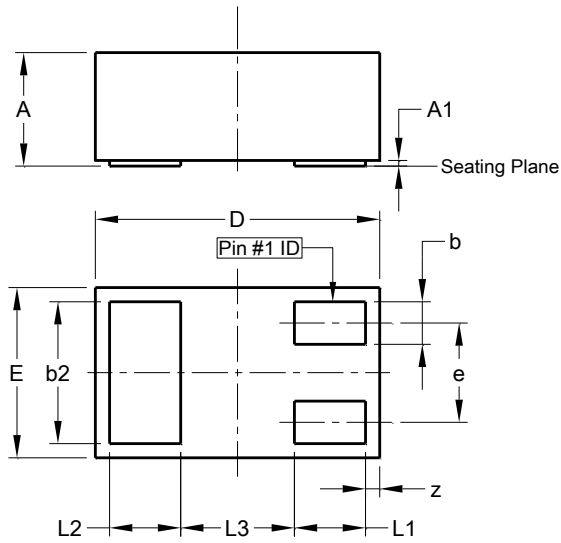

Fig. 9 Typical Capacitance

Package Outline Dimensions



X2-DFN1006-3			
Dim	Min	Max	Typ
A	—	0.40	—
A1	0.00	0.05	0.03
b	0.10	0.20	0.15
b2	0.45	0.55	0.50
D	0.95	1.05	1.00
E	0.55	0.65	0.60
e	-	-	0.35
L1	0.20	0.30	0.25
L2	0.20	0.30	0.25
L3	-	-	0.40
z	0.02	0.08	0.05
All Dimensions in mm			

Suggested Pad Layout

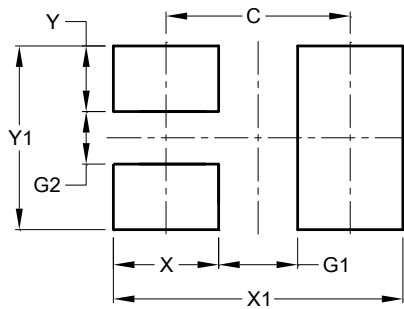

Dimensions	Value (in mm)
C	0.70
G1	0.30
G2	0.20
X	0.40
X1	1.10
Y	0.25
Y1	0.70

