

GENERAL DESCRIPTION

The SGM5532 is a high-performance operational amplifier combining excellent DC and AC characteristics. It features very low noise, high output-drive capability, high unity-gain and maximum output-swing bandwidths, low distortion, high slew rate, input protection diodes and output short-circuit protection. The operational amplifier is compensated internally for unity-gain operation.

The SGM5532 is available in Green SOIC-8 package. It operates over an ambient temperature range of -40°C to +85°C.

FEATURES

- **Equivalent Input Noise Voltage:**
 $5nV/\sqrt{Hz}$ (TYP) at 1kHz
- **Unity-Gain Bandwidth:** 8.5MHz (TYP)
- **Common Mode Rejection Ratio:** 140dB (TYP)
- **High DC Voltage Gain:** 140dB (TYP)
- **High Slew Rate:** 18V/ μ s (TYP)
- **-40°C to +85°C Operating Temperature Range**
- **Available in Green SOIC-8 Package**

APPLICATIONS

- AV Receivers
- Embedded PCs
- Netbooks
- Video Broadcasting and Infrastructure: Scalable Platforms
- DVD Recorders and Players
- Multichannel Video Transcoders
- Pro Audio Mixers

SIMPLIFIED SCHEMATIC

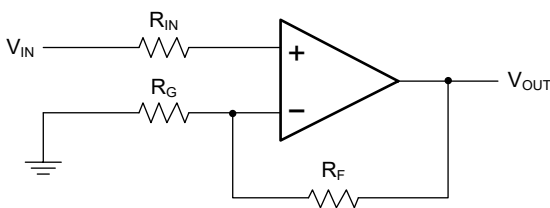
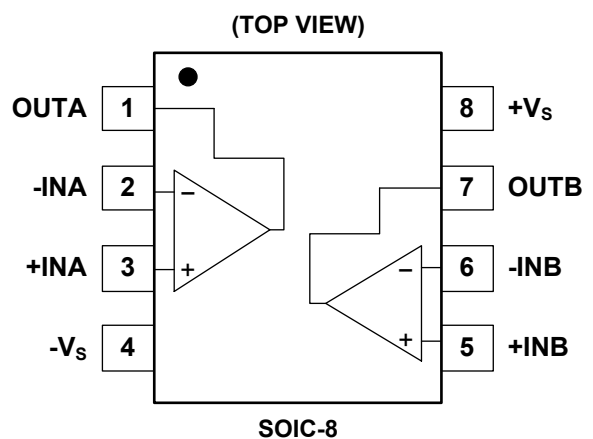

Figure 1. Simplified Schematic

PIN CONFIGURATION



PACKAGE/ORDERING INFORMATION

MODEL	PACKAGE DESCRIPTION	SPECIFIED TEMPERATURE RANGE	ORDERING NUMBER	PACKAGE MARKING	PACKING OPTION
SGM5532	SOIC-8	-40°C to +85°C	SGM5532YS8G/TR	SGM 5532YS8 XXXXX	Tape and Reel, 4000

NOTE: XXXXX = Date Code and Vendor Code.

Green (RoHS & HSF): SG Micro Corp defines "Green" to mean Pb-Free (RoHS compatible) and free of halogen substances. If you have additional comments or questions, please contact your SGMICRO representative directly.

ABSOLUTE MAXIMUM RATINGS

Supply Voltage, +V_S to -V_S..... 40V
 Input Common Mode Voltage Range
 (-V_S) - 0.3V to (+V_S) + 0.3V
 Junction Temperature +150°C
 Storage Temperature Range..... -65°C to +150°C
 Lead Temperature (Soldering, 10s) +260°C
 ESD Susceptibility
 HBM..... 5000V
 MM..... 200V
 CDM 1000V

RECOMMENDED OPERATING CONDITIONS

Supply Voltage, +V_S to -V_S..... 5V to 36V
 Operating Temperature Range -40°C to +85°C

OVERSTRESS CAUTION

Stresses beyond those listed may cause permanent damage to the device. Functional operation of the device at these or any other conditions beyond those indicated in the operational section of the specification is not implied. Exposure to absolute maximum rating conditions for extended periods may affect reliability.

ESD SENSITIVITY CAUTION

This integrated circuit can be damaged by ESD if you don't pay attention to ESD protection. SGMICRO recommends that all integrated circuits be handled with appropriate precautions. Failure to observe proper handling and installation procedures can cause damage. ESD damage can range from subtle performance degradation to complete device failure. Precision integrated circuits may be more susceptible to damage because very small parametric changes could cause the device not to meet its published specifications.

DISCLAIMER

SG Micro Corp reserves the right to make any change in circuit design, specification or other related things if necessary without notice at any time.

ELECTRICAL CHARACTERISTICS

(At $T_A = +25^\circ\text{C}$, Full = -40°C to $+85^\circ\text{C}$, $V_S = \pm 15\text{V}$, $R_L = 2\text{k}\Omega$ connected to 0V , unless otherwise noted.)

PARAMETER	SYMBOL	CONDITIONS	TEMP	MIN	TYP	MAX	UNITS
INPUT CHARACTERISTICS							
Input Offset Voltage	V_{OS}	$V_{CM} = 0\text{V}$	+25°C		100	500	μV
			Full			620	
Input Offset Voltage Drift	$\Delta V_{OS}/\Delta T$		Full		0.6		$\mu\text{V}/^\circ\text{C}$
Input Bias Current	I_B	$V_{CM} = 0\text{V}$	+25°C		550	750	nA
			Full			900	
Input Offset Current	I_{OS}	$V_{CM} = 0\text{V}$	+25°C		10	70	nA
			Full			100	
Input Common Mode Voltage Range	V_{CM}		Full	-13		13	V
Common Mode Rejection Ratio	CMRR	$V_S = \pm 15\text{V}$, $-13\text{V} < V_{CM} < 13\text{V}$	+25°C	128	140		dB
			Full	124			
Open-Loop Voltage Gain	A_{OL}	$V_S = \pm 15\text{V}$, $V_{OUT} = \pm 10\text{V}$, $R_L = 2\text{k}\Omega$	+25°C	128	140		dB
			Full	120			
			+25°C	112	128		
			Full	108			
OUTPUT CHARACTERISTICS							
Output Voltage Swing from Rail	V_{OUT}	$V_S = \pm 15\text{V}$, $R_L = 2\text{k}\Omega$	+25°C		150	185	mV
			Full			230	
			+25°C		550	660	
			Full			840	
Output Short-Circuit Current	I_{SC}	$V_S = \pm 15\text{V}$	+25°C	± 27	± 36		mA
POWER SUPPLY							
Operating Voltage Range	V_S		Full	5		36	V
Quiescent Current	I_Q	$I_{OUT} = 0$	+25°C		8.5	17.5	mA
			Full			18	
Power Supply Rejection Ratio	PSRR	$V_S = 5\text{V}$ to 36V	+25°C	122	138		dB
			Full	119			
DYNAMIC PERFORMANCE							
Gain-Bandwidth Product	GBP	$f = 10\text{kHz}$			20		MHz
Slew Rate	SR				18		$\text{V}/\mu\text{s}$
Overload Recovery Time	ORT	$V_{IN} \times G = V_S$			1.2		μs
Maximum Output-Swing Bandwidth	B_{OM}	$V_S = \pm 15\text{V}$, $V_{OUT} = \pm 10\text{V}$, $R_L = 600\Omega$			280		kHz
Unity-Gain Bandwidth	B_1	$R_L = 600\Omega$			8.5		MHz
Total Harmonic Distortion + Noise	THD+N	$V_S = \pm 15\text{V}$, $V_{OUT} = 10\text{V}_{P-P}$, $f = 1\text{kHz}$, $G = +1$, $R_L = 600\Omega$			0.00005		%
NOISE							
Input Voltage Noise		$f = 0.1\text{Hz}$ to 10Hz			0.3		μV_{P-P}
Input Voltage Noise Density	e_n	$f = 30\text{Hz}$			15		$\text{nV}/\sqrt{\text{Hz}}$
		$f = 1\text{kHz}$			5		
Input Current Noise Density	i_n	$f = 30\text{Hz}$			3		$\text{pA}/\sqrt{\text{Hz}}$
		$f = 1\text{kHz}$			1		

TYPICAL PERFORMANCE CHARACTERISTICS

At $T_A = +25^\circ\text{C}$, $V_S = \pm 15\text{V}$ and $R_L = 2\text{k}\Omega$, unless otherwise noted.

Large-Signal Step Response

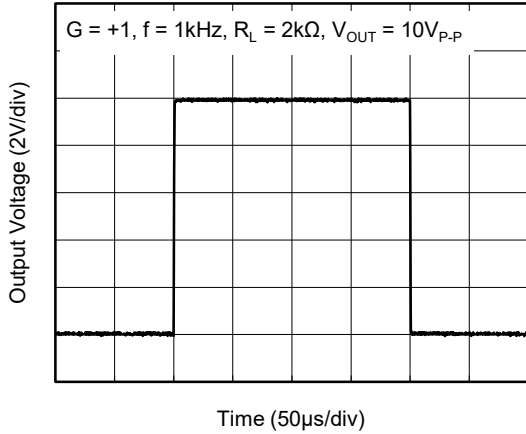

Small-Signal Step Response

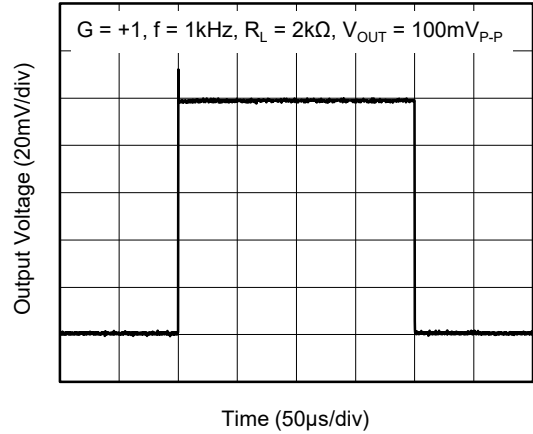

Positive Overload Recovery

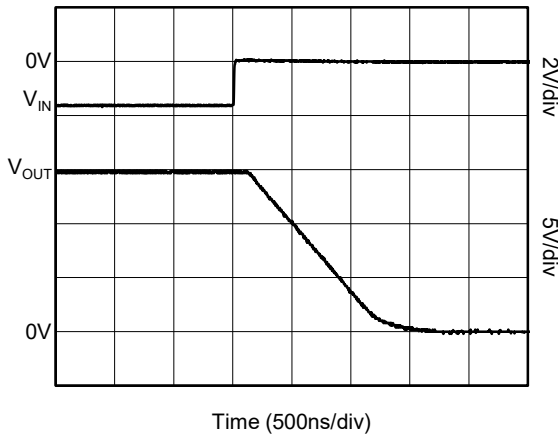

Negative Overload Recovery

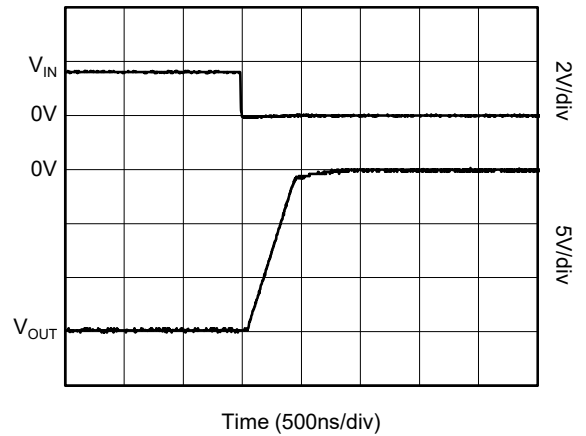

Input Offset Voltage vs. Input Common Mode Voltage

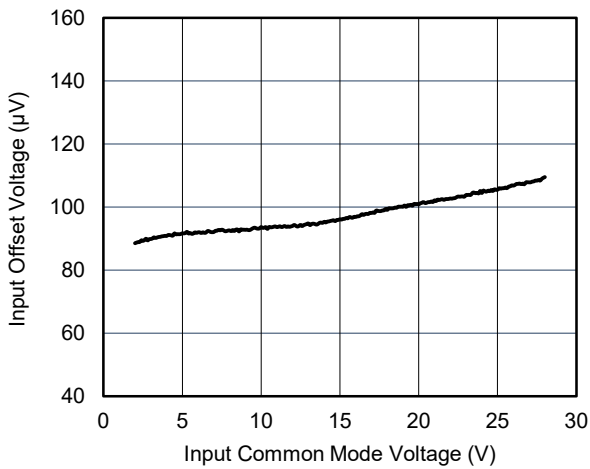

Output Voltage vs. Output Current

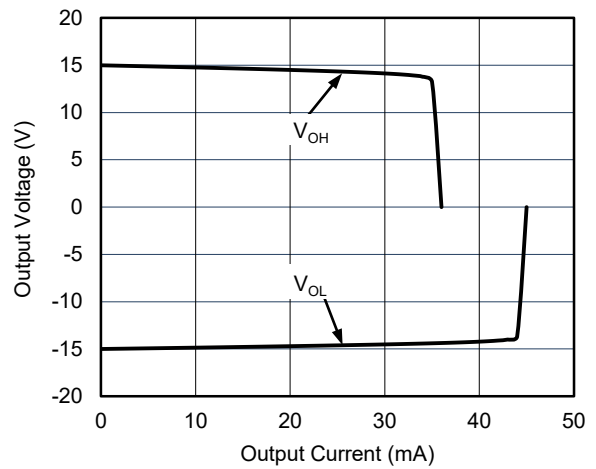

TYPICAL PERFORMANCE CHARACTERISTICS (continued)

At $T_A = +25^\circ\text{C}$, $V_S = \pm 15\text{V}$ and $R_L = 2\text{k}\Omega$, unless otherwise noted.

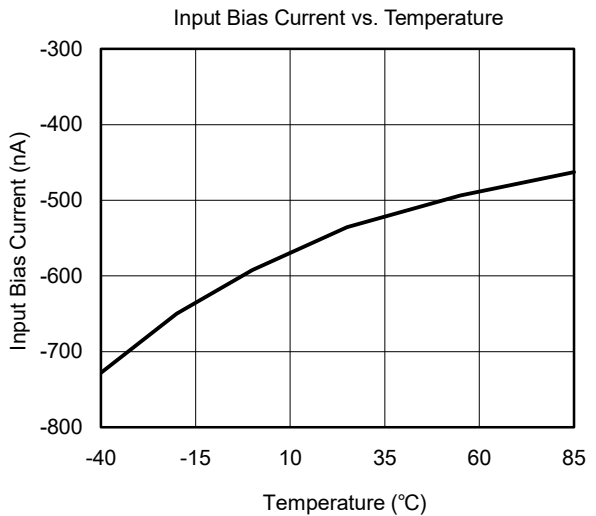
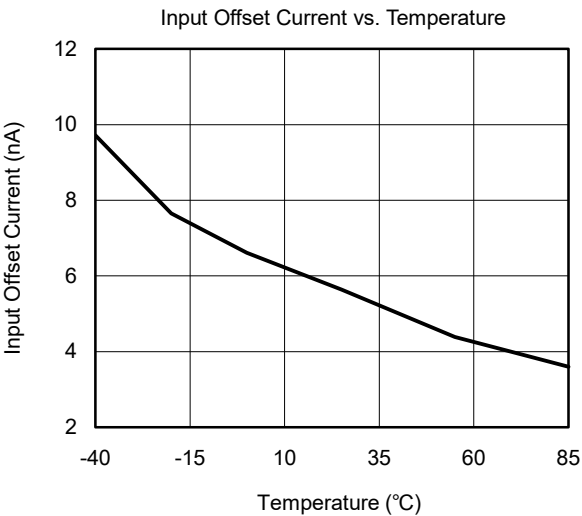
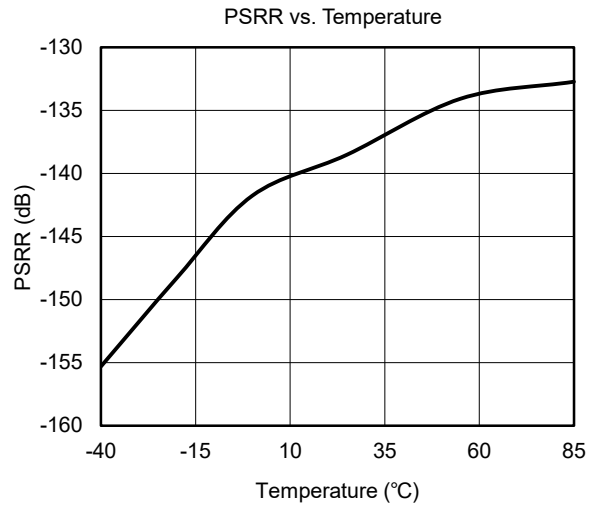
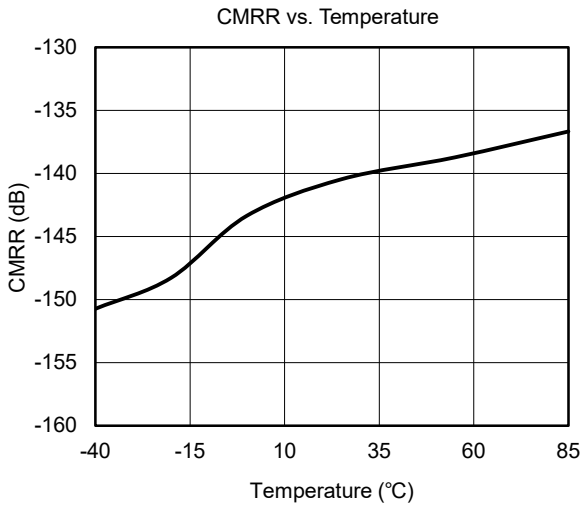
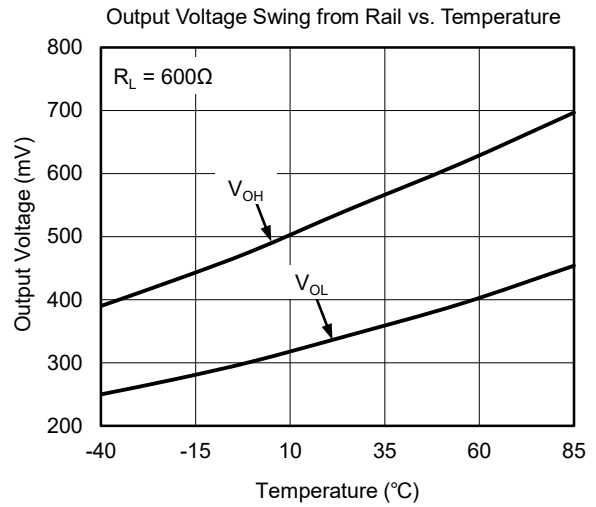
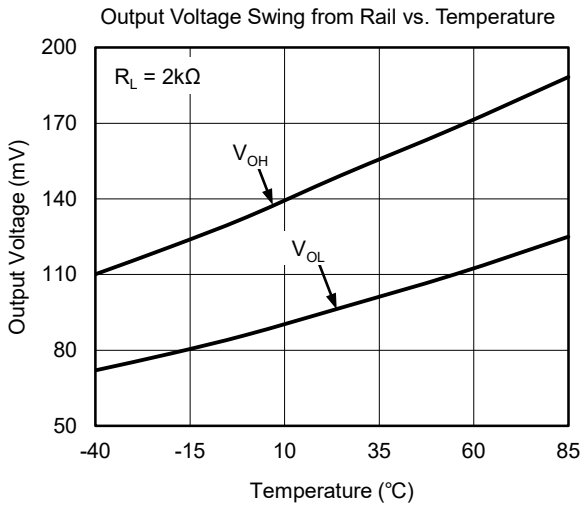

TYPICAL PERFORMANCE CHARACTERISTICS (continued)

At $T_A = +25^\circ\text{C}$, $V_S = \pm 15\text{V}$ and $R_L = 2\text{k}\Omega$, unless otherwise noted.

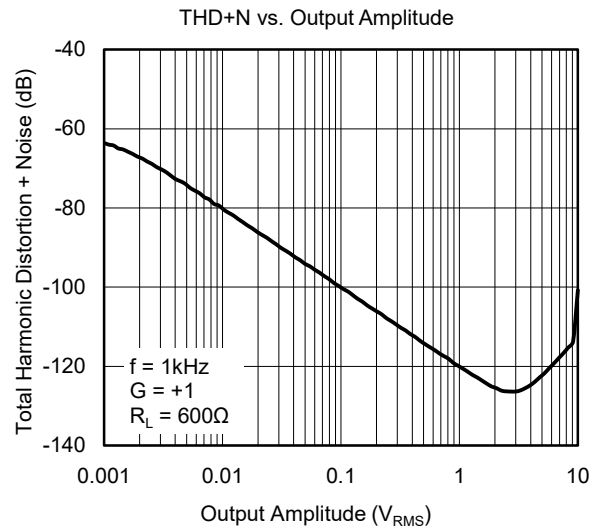
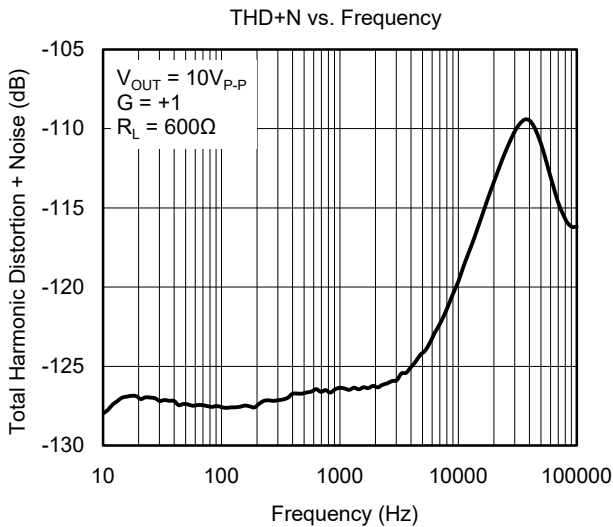
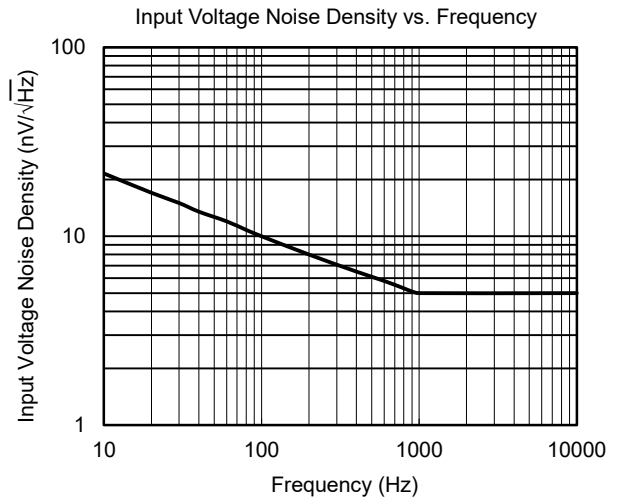
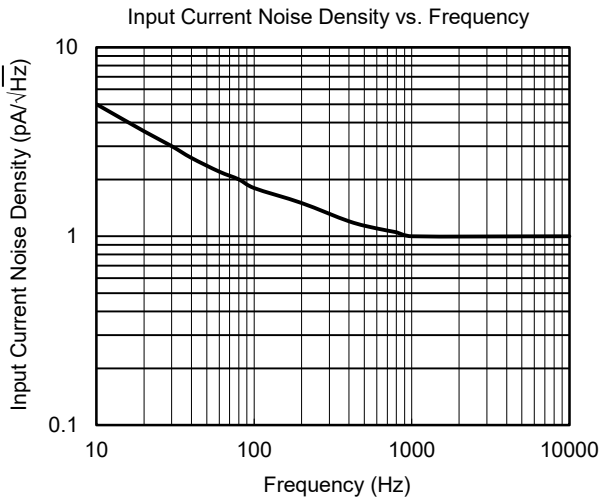
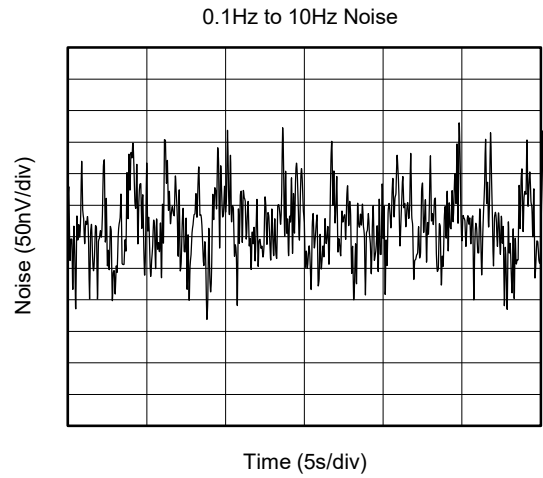
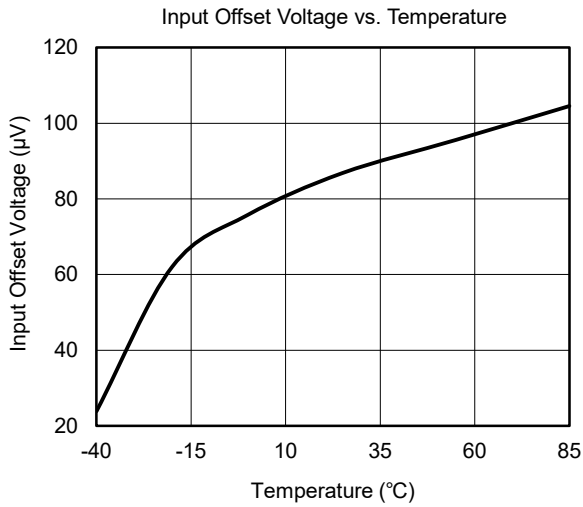

TYPICAL PERFORMANCE CHARACTERISTICS (continued)

At $T_A = +25^\circ\text{C}$, $V_S = \pm 15\text{V}$ and $R_L = 2\text{k}\Omega$, unless otherwise noted.

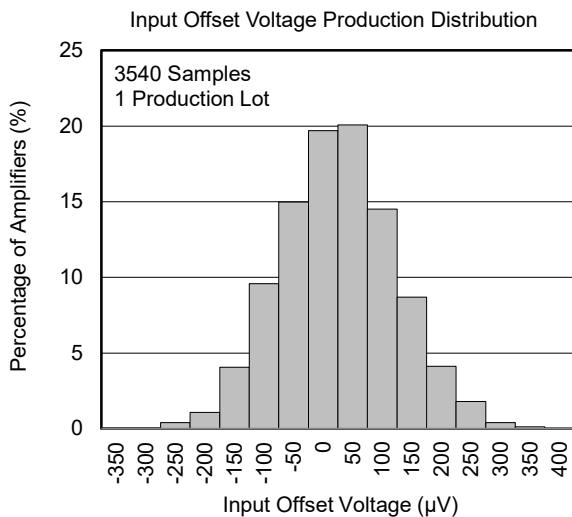
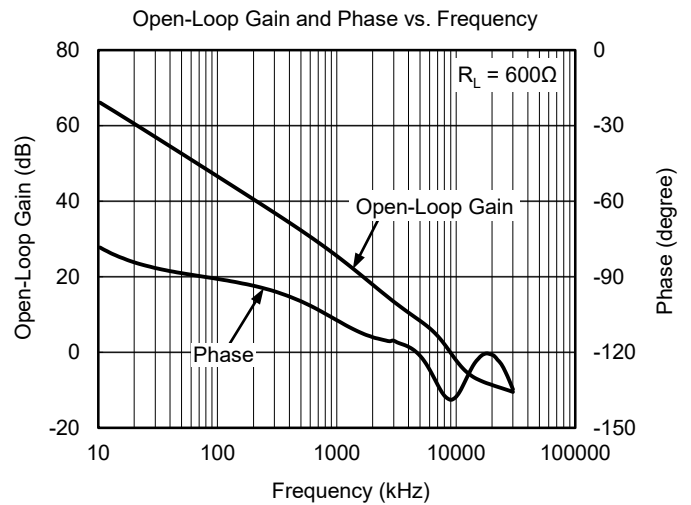
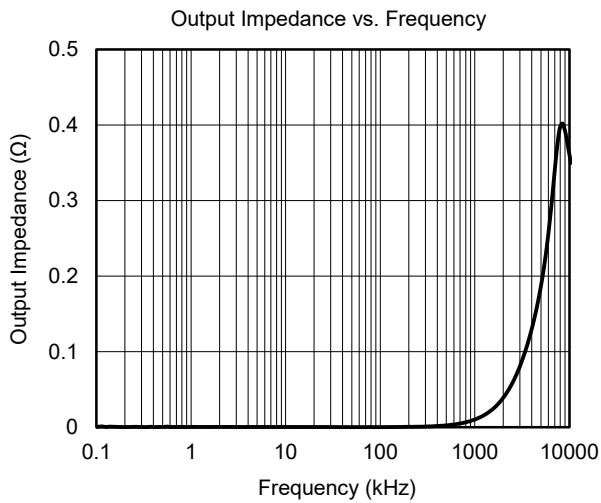

DETAILED DESCRIPTION

The SGM5532 is a high-performance operational amplifier combining excellent DC and AC characteristics. It features very low noise, high output-drive capability, high unity-gain and maximum output-swing bandwidth, low distortion, high slew rate, input-protection diodes and output short-circuit protection. The operational amplifier is compensated internally for unity-gain operation.

Unity-Gain Bandwidth

The unity-gain bandwidth is the frequency up to which an amplifier with a unity gain may be operated without greatly distorting the signal. The SGM5532 device has an 8.5MHz unity-gain bandwidth.

Common Mode Rejection Ratio

The common mode rejection ratio (CMRR) of an amplifier is a measure of how well the device rejects unwanted input signals common to both input leads. It

is found by taking the ratio of the change in input offset voltage to the change in the input common mode voltage and converting to decibels. The CMRR of the SGM5532 device is 140dB.

Slew Rate

The slew rate is the rate at which an operational amplifier can change its output when there is a change on the input. The SGM5532 device has an 18V/ μ s slew rate.

Device Functional Modes

The SGM5532 device is powered on when the supply is connected. The device can be operated as a single supply operational amplifier or dual supply amplifier depending on the application.

POWER SUPPLY RECOMMENDATIONS

The SGM5532 device is specified for operation over the range of $\pm 2.5V$ to $\pm 18V$; many specifications apply from $-40^{\circ}C$ to $+85^{\circ}C$. Place 0.1 μ F bypass capacitors close to the power-supply pins to reduce errors coupling in from noisy or high impedance power supplies. For more detailed information on bypass capacitor placement, refer to the Layout Guidelines.

Caution

Supply voltages outside of the $\pm 18V$ range can permanently damage the device (see the Absolute Maximum Ratings).

APPLICATION INFORMATION

Some applications require differential signals. Figure 2 shows a simple circuit to convert a single-ended input of 2V to 10V into differential output of $\pm 8V$ on a single 15V supply. The output range is intentionally limited to maximize linearity. The circuit is composed of two

amplifiers. One amplifier acts as a buffer and creates a voltage, V_{OUT+} . The second amplifier inverts the input and adds a reference voltage to generate V_{OUT-} . Both V_{OUT+} and V_{OUT-} range from 2V to 10V. The difference, V_{DIFF} , is the difference between V_{OUT+} and V_{OUT-} .

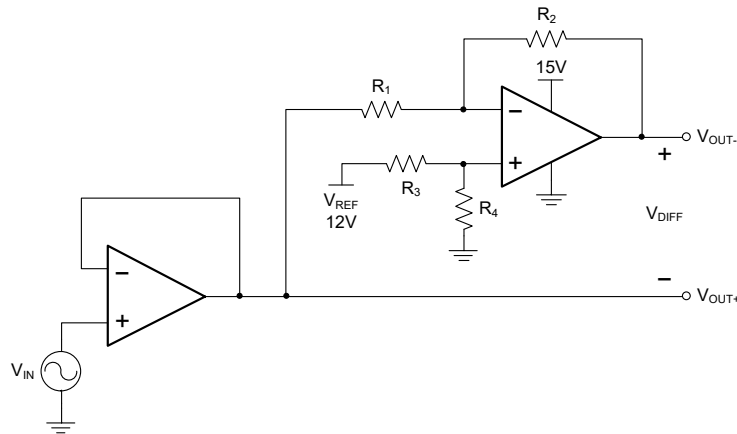

Figure 2. Schematic for Single-Ended Input to Differential Output Conversion

Detailed Design Procedure

The circuit in Figure 2 takes a single-ended input signal, V_{IN} , and generates two output signals, V_{OUT+} and V_{OUT-} using two amplifiers and a reference voltage, V_{REF} . V_{OUT+} is the output of the first amplifier and is a buffered version of the input signal, V_{IN} in Equation 1. V_{OUT-} is the output of the second amplifier which uses V_{REF} to add an offset voltage to V_{IN} and feedback to add inverting gain. The transfer function for V_{OUT-} is Equation 2.

$$V_{OUT+} = V_{IN} \quad (1)$$

$$V_{OUT-} = V_{REF} \times \left(\frac{R_4}{R_3 + R_4} \right) \times \left(1 + \frac{R_2}{R_1} \right) - V_{IN} \times \frac{R_2}{R_1} \quad (2)$$

The differential output signal, V_{DIFF} , is the difference between the two single-ended output signals, V_{OUT+} and V_{OUT-} . Equation 3 shows the transfer function for V_{DIFF} . By applying the conditions that $R_1 = R_2$ and $R_3 = R_4$, the transfer function is simplified into Equation 6. Using this configuration, the maximum input signal is equal to the reference voltage and the maximum output of each amplifier is equal to the V_{REF} . The differential output range is $2 \times V_{REF}$. Furthermore, the common mode voltage will be one half of V_{REF} (see Equation 7).

$$V_{DIFF} = V_{OUT+} - V_{OUT-} = V_{IN} \times \left(1 + \frac{R_2}{R_1} \right) - V_{REF} \times \left(\frac{R_4}{R_3 + R_4} \right) \left(1 + \frac{R_2}{R_1} \right) \quad (3)$$

$$V_{OUT+} = V_{IN} \quad (4)$$

$$V_{OUT-} = V_{REF} - V_{IN} \quad (5)$$

$$V_{DIFF} = 2 \times V_{IN} - V_{REF} \quad (6)$$

$$V_{CM} = \left(\frac{V_{OUT+} + V_{OUT-}}{2} \right) = \frac{1}{2} V_{REF} \quad (7)$$

Amplifier Selection

Linearity over the input range is key for good DC accuracy. The input common mode range and the output swing limitations determine the linearity. In general, an amplifier with rail-to-rail input and output swing is required. Bandwidth is a key concern for this design. Since the SGM5532 has a bandwidth of 8.5MHz, this circuit will only be able to process signals with frequencies of less than 8.5MHz.

Passive Component Selection

Because the transfer function of V_{OUT-} is heavily reliant on resistors (R_1 , R_2 , R_3 , and R_4), use resistors with low tolerances to maximize performance and minimize error. This design used resistors with resistance values of 36k Ω with tolerances measured to be within 2%. But, if the noise of the system is a key parameter, the user can select smaller resistance values (6k Ω or lower) to keep the overall system noise low. This ensures that the noise from the resistors is lower than the amplifier noise.

LAYOUT

Layout Guidelines

For best operational performance of the device, use good PCB layout practices, including:

- Noise can propagate into analog circuitry through the power pins of the circuit as a whole and the operational amplifier. Bypass capacitors are used to reduce the coupled noise by providing low impedance power sources local to the analog circuitry.
- Connect low-ESR, 0.1µF ceramic bypass capacitors between each supply pin and ground, placed as close to the device as possible. A single bypass capacitor from +V_S to ground is applicable for single supply applications.
- Separate grounding for analog and digital portions of circuitry is one of the simplest and most-effective methods of noise suppression. One or more layers on multilayer PCBs are usually devoted to ground planes. A ground plane helps distribute heat and reduces EMI noise pickup. Make sure to physically separate digital and analog grounds, paying attention to the flow of the ground current.
- To reduce parasitic coupling, run the input traces as far away from the supply or output traces as possible.

better to cross the sensitive trace perpendicular as opposed to in parallel with the noisy trace.

- Place the external components as close to the device as possible. Keeping R_F and R_G close to the inverting input minimizes parasitic capacitance, as shown in Figure 3.
- Keep the length of input traces as short as possible. Always remember that the input traces are the most sensitive part of the circuit.
- Consider a driven, low-impedance guard ring around the critical traces. A guard ring can significantly reduce leakage currents from nearby traces that are at different potentials.

Layout Example

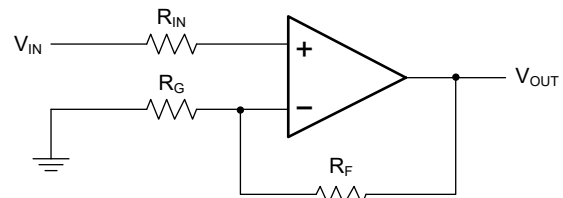

Figure 3. Operational Amplifier Schematic for Non-Inverting Configuration

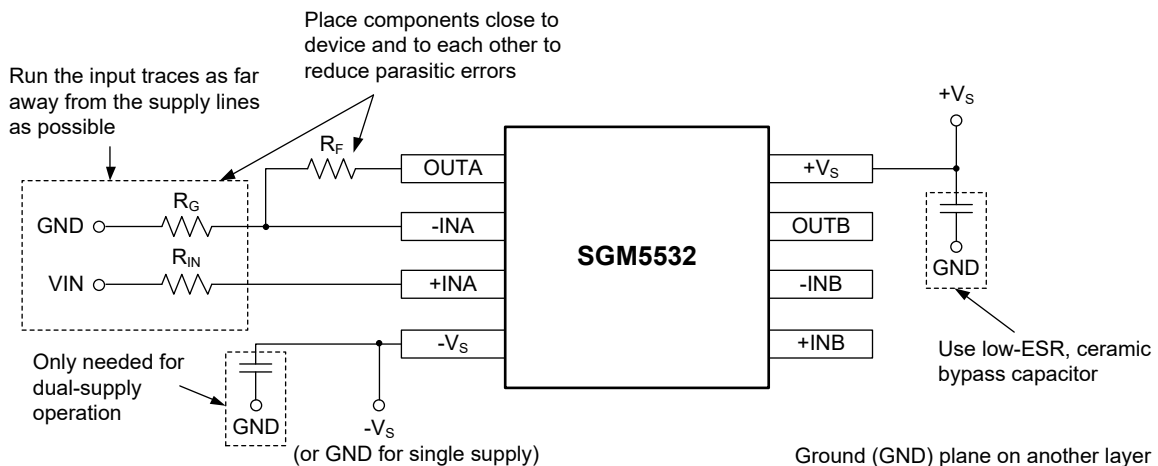

Figure 4. Operational Amplifier Board Layout for Non-Inverting Configuration

REVISION HISTORY

NOTE: Page numbers for previous revisions may differ from page numbers in the current version.

APRIL 2018 – REV.A to REV.A.1

Updated Electrical Characteristics section 3

Changes from Original (DECEMBER 2017) to REV.A

Changed from product preview to production data..... All

PACKAGE OUTLINE DIMENSIONS

SOIC-8

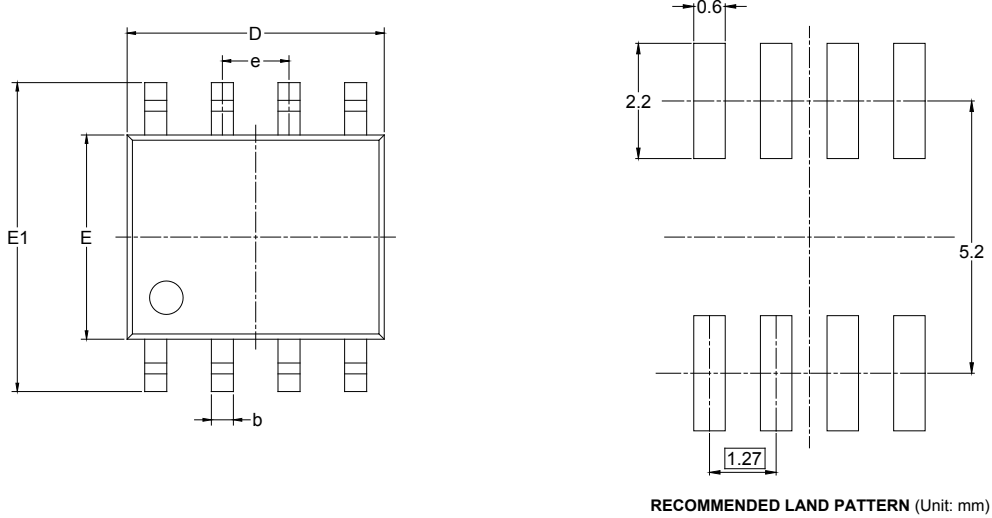

Symbol	Dimensions In Millimeters		Dimensions In Inches	
	MIN	MAX	MIN	MAX
A	1.350	1.750	0.053	0.069
A1	0.100	0.250	0.004	0.010
A2	1.350	1.550	0.053	0.061
b	0.330	0.510	0.013	0.020
c	0.170	0.250	0.006	0.010
D	4.700	5.100	0.185	0.200
E	3.800	4.000	0.150	0.157
E1	5.800	6.200	0.228	0.244
e	1.27 BSC		0.050 BSC	
L	0.400	1.270	0.016	0.050
θ	0°	8°	0°	8°

TAPE AND REEL INFORMATION

REEL DIMENSIONS

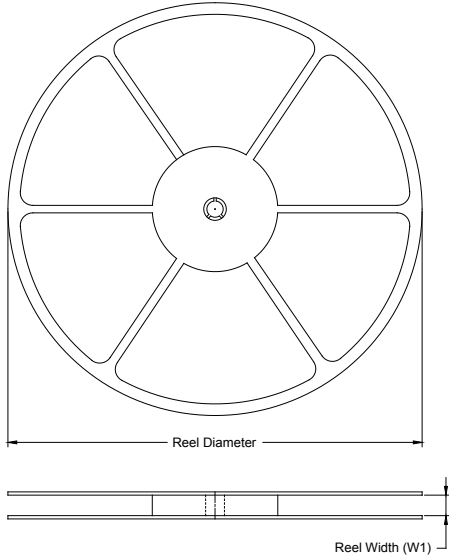

TAPE DIMENSIONS

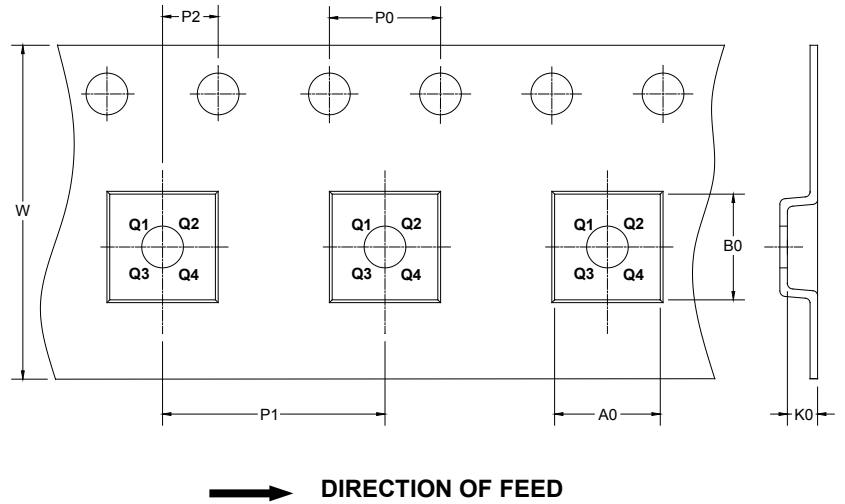

NOTE: The picture is only for reference. Please make the object as the standard.

KEY PARAMETER LIST OF TAPE AND REEL

Package Type	Reel Diameter	Reel Width W1 (mm)	A0 (mm)	B0 (mm)	K0 (mm)	P0 (mm)	P1 (mm)	P2 (mm)	W (mm)	Pin1 Quadrant
SOIC-8	13"	12.4	6.40	5.40	2.10	4.0	8.0	2.0	12.0	Q1

000001

PACKAGE INFORMATION

CARTON BOX DIMENSIONS



NOTE: The picture is only for reference. Please make the object as the standard.

KEY PARAMETER LIST OF CARTON BOX

Reel Type	Length (mm)	Width (mm)	Height (mm)	Pizza/Carton
13"	386	280	370	5

DD0002